



**MADE FOR LIFE  
GUARANTEED FOR LIFE**



## ACM-1000 Clamp Meter Instruction Manual

## Preface

Thank you for purchasing the ACM-1000. In order to use this product safely and correctly, please read this manual thoroughly, especially the *Safety Instructions* part.

After reading this manual, it is recommended to keep the manual at an easily accessible place, preferably close to the device, for future reference.

## Limited Warranty and Liability

Jonard guarantees that the product is free from any defect in material and workmanship within one year from the purchase date. This warranty does not apply to damages caused by accident, negligence, misuse, modification, contamination or mishandling. The dealer shall not be entitled to give any other warranty on behalf of Jonard. If you need warranty service within the warranty period, please contact your seller directly.

Jonard will not be responsible for any special, indirect, incidental or subsequent damage or loss caused by using this device.



## Table of Contents

I. Overview -----	4
II. Accessories -----	4
III. Safety Instructions -----	5
IV. Electrical Symbols -----	6
V. External Structure -----	7
VI. LCD Display -----	8
VII. Function SwitchDial and Function Buttons -----	11
VIII. Specifications -----	13
IX. Operating Instructions -----	22
X. Maintenance -----	38

## I. Overview

The ACM-1000 is a 6000-count handheld true RMS clamp meter with auto range. This full scale overload protection meter contains the following features:

- AC/DC voltage, AC current, resistance, diode, continuity, capacitance, frequency, duty ratio, data hold, MAX/MIN, relative
- Flashlight, NCV, low battery indication, and auto power off



### **Warning:**

Before using the meter, please read the Safety Instructions carefully.

## II. Accessories

Open the package box and take out the meter. Please double check whether the following items are missing or damaged.

- |                             |        |
|-----------------------------|--------|
| a) User manual -----        | 1 pc   |
| b) Test leads -----         | 1 pair |
| c) Hard case -----          | 1 pc   |
| d) 1.5V AAA batteries ----- | 3 pcs  |

If any of the above is missing or damaged, please contact your supplier immediately.













### III. Safety Instructions

The meter is designed and manufactured according to UL STD 61010-1, 61010-2-032, 61010-2-033, safety standards, and conforms to CAT III 1000V, CAT IV 600V, double insulation, and pollution degree 2.

**⚠ Note:** Before each use, verify meter operation by measuring a known voltage. If the meter is used in a manner not specified by the manufacturer, the protection provided by the equipment may not be guaranteed.

1. Before use, please check if there is any item which is damaged or behaving abnormally. If any abnormal item (such as bare test lead, damaged meter casing, broken LCD, etc.) is found, or if the meter is considered to be malfunctioning, please do not continue to use the meter.
2. Do not use the meter if the rear cover or the battery cover is not completely covered up, it may pose a shock hazard!
3. When using the meter, keep fingers behind the finger guards of the test leads, and do not touch exposed wires, connectors, unused inputs, or circuits being measured to prevent electric shock.
4. The function dial should be placed in the correct position before measurement.
5. Do not apply voltage over 1000V between any meter terminal and earth ground to prevent electric shock or damage to the meter.
6. Use caution when working with voltage above AC 30Vrms, 42Vpeak or DC 60V. Such voltages pose a shock hazard.
7. Never input voltage or current which exceeds the specified limit. If the range of the measured value is unknown, the maximum range should be selected.
8. Before measuring the resistance, diode and continuity, switch off the power supply of the circuit, and fully discharge all capacitors to avoid inaccurate measurement.
9. When the “” symbol appears on the LCD, please replace the batteries in time to ensure measurement accuracy. If the meter is not in use for a long time, please remove the batteries.
10. Do not change the internal circuit of the meter to avoid damage to the meter and user!
11. Do not use or store the meter in high temperature, high humidity, flammable, explosive or strong magnetic field environments.
12. Clean the meter casing with a soft cloth and mild detergent. Do not use abrasives or solvents!

### IV. Electrical Symbols

Symbol	Description
	Equipment protected throughout by DOUBLE INSULATION or REINFORCED INSULATION
	Earth (ground)
	Warning or Caution
	Alternating current
	Direct current
	Continuity buzzer
	Diode
	Capacitance
	Alternating current or direct current
	Caution, possibility of electric shock
	Application around and removal from UNINSULATED HAZARDOUS LIVE conductors is permitted.
	Complies with European Union standards
	Conforms to UL STD 61010-1, 61010-2-032, 61010-2-033, Certified to CSA STD C22.2 No. 61010-1, 61010-2-032, 61010-2-033.
<b>CAT III</b>	It is applicable to testing and measuring circuits connected to the distribution part of the building's low-voltage MAINS installation.
<b>CAT IV</b>	It is applicable to testing and measuring circuits connected at the source of the building's low-voltage MAINS installation.

## V. External Structure (Picture 1)

1. Clamp jaws
2. Hand guard
3. LED indicator light
4. Jaw opening trigger
5. Function dial
6. LCD display
7. Function button
8. NCV sensor
9. FLIGHT button
10. Flashlight LED light
11. Batter cover
12. Input jacks

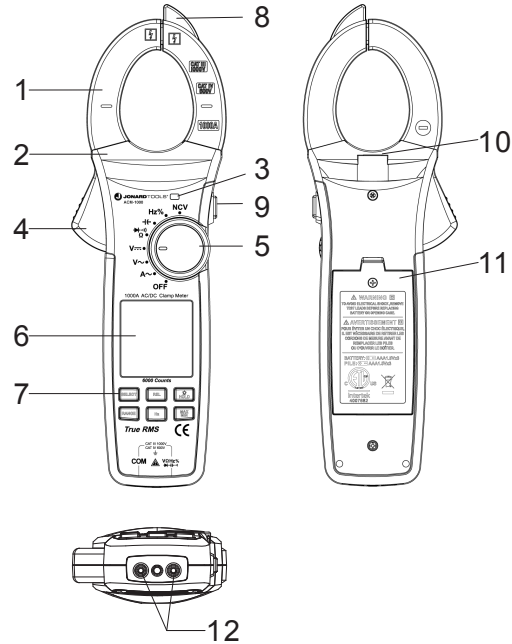

Picture 1

## VI. LCD Display (Picture 2)

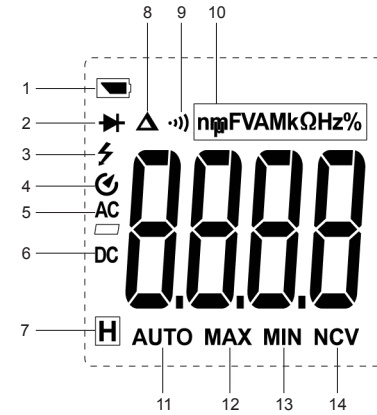

Picture 2

1.	Low battery	8.	Relative value
2.	Diode test	9.	Continuity test
3.	High voltage	10.	Unit
4.	Auto power off	11.	Auto range
5.	AC signal	12.	Max measurement
6.	DC signal	13.	Min measurement
7.	Data hold	14.	NCV

## VII. Function Dial and Function Buttons

### 1. Function Dial

	AC amperpage
	VOLTS
	RESISTANCE
	RELATIVE CAPACITANCE
	RELATIVE PERMITTIVITY
	RELATIVE PERMEABILITY
	FREQUENCY
	RELATIVE HUMIDITY
	NON-CONDUCTIVE VOLTAGE
	OFF

### 2. Function Buttons

Note:

Short press: (once) to select a function.

Long press: (long) to select a function.

#### 1) SELECT Button

Short press: (once) to select a function.

Long press: (long) to select a function.

#### 2) HOLD/HZ Button

Short press: (once) to hold the reading.

Long press: (long) to hold the reading.

#### 3) MAX/MIN Button

Short press: (once) to hold the maximum or minimum reading.

Long press: (long) to hold the maximum or minimum reading.

#### 4) REL or REL ZERO Button

Short press: (once) to set the reading to zero.

Long press: (long) to set the reading to zero.

U) | (once) to set the reading to zero.

U) | (long) to set the reading to zero.

#### 5) RANGE Button

Short press: (once) to change the range.

Long press: (long) to change the range.

## 2. Function Buttons, con't

### 6) Hz Button

**Short press:** enter/exit the frequency measurement mode.

### 7) LIGHT Button

**Short press:** turn on/off the flashlight.

## VIII. Specifications

### 1. General Specifications

Max display: ----- 6000 counts  
 Polarity display: ----- Auto  
 Overload display: ----- "OL" or "-OL"  
 Low battery indication: ----- "  " is displayed.  
 Sampling rate: ----- 3 times/s  
 Sensor type: ----- Coil induction  
 Test position error: ----- If the source under test is not placed at the center of the clamp jaws when measuring current, ±1.0% additional error in reading may be produced.  
 Jaw opening: ----- 42mm  
 Battery: ----- 3×1.5V AAA  
 Auto power off: ----- 15 minutes (can be disabled)  
 Dimensions: ----- 272mm×81mm×43.5mm  
 Weight (including batteries): ----- About 492g

## 2. Environmental Specifications

Operating altitude:----- 2000m  
 Safety standards:----- UL STD 61010-1,61010-2-032, 61010-2-033  
 Pollution degree:----- 2  
 Storage temperature and humidity:----- -10°C~60°C (≤80%RH)  
 Electromagnetic compatibility:----- When RF=1V/m:  
 overall accuracy = specified accuracy + 5% of range  
 When RF>1V/m: not specified

## 3. Electrical specifications

Accuracy:----- ± (a% of reading + b digits), 1 year calibration cycle  
 Ambient temperature:----- 23°C±5°C  
 Ambient humidity:----- ≤80%RH

### **Note:**

To ensure measurement accuracy, the operating temperature should be within 18°C~28°C and the fluctuation range should be within ±1°C. When the temperature is <18°C or >28°C, add temperature coefficient error 0.1 x (specified accuracy)/°C.

### 4.5.7 7i ffYbhfifl<sub>A</sub>Ł

Range	Resolution	Accuracy	Overload Protection
60.00A	0.01A	± (2.0%+5)	1000A
600.0A	0.1A		
1000A	1A		

- Display: True RMS
- Accuracy guarantee: 5%~100% of range. Open circuit allows least significant digit ≤ 10.
- Frequency response: 50Hz~60Hz
- When the measured current is above 500A, the continuous measurement time cannot exceed 60s.
- The AC crest factor will reach 3.0 at 3000 counts while only reach ≤ 1.5 at 6000 counts. The additional error should be added according to the crest factor of a non-sinusoidal wave are:
  - Add 4% when crest factor is 1~2
  - Add 5% when crest factor is 2~2.5
  - Add 7% when crest factor is 2.5~3
- For current frequency monitoring, the resolution is 0.1Hz and accuracy is ± (0.1%+3). The input amplitude should be ≥ 10% of range.

### 5.5.7 Jc`HJ Y ffVŁ

Range	Resolution	Accuracy	Overload Protection
6.000V	0.001V	± (1.2%+3)	1000V DC/AC
± (1.0%+8)	0.01V	± (1.0%+8)	
600.0V	0.1V		
1000V	1V		

- Display: True RMS
- Accuracy guarantee: 5%~100% of range. Short circuit allows least significant digit ≤ 5.
- Input impedance: ≥ 10MΩ
- Frequency response: 40Hz~400Hz
- The AC crest factor will reach 3.0 at 3000 counts while only reach ≤ 1.5 at 6000 counts. The additional error should be added according to the crest factor of a non-sinusoidal wave are:
  - Add 4% when crest factor is 1~2
  - Add 5% when crest factor is 2~2.5
  - Add 7% when crest factor is 2.5~3
- For voltage frequency monitoring, the resolution is 0.1Hz and accuracy is ± (0.1%+3). The input amplitude should be ≥ 10% of range.

## 6) DC Voltage ( $\bar{V}$ )

Range	Resolution	Accuracy	Overload Protection
600.0mV	0.1mV	$\pm (0.8\%+3)$	1000V DC/AC
6.000V	0.001V	$\pm (0.5\%+5)$	
60.00V	0.01V		
600.0V	0.1V		
1000V	1V		

- Input impedance:  $\geq 10M\Omega$
- Accuracy guarantee: 5%~100% of range. Short circuit allows least significant digit  $\leq 5$ .

## 7) Resistance ( $\Omega$ )

Range	Resolution	Accuracy	Overload Protection
600.0 $\Omega$	0.1 $\Omega$	$\pm (1.0\%+3)$	1000V DC/AC
6.000k $\Omega$	0.001k $\Omega$	$\pm (1.0\%+2)$	
60.00k $\Omega$	0.01k $\Omega$		
600.0k $\Omega$	0.1k $\Omega$		
6.000M $\Omega$	0.001M $\Omega$	$\pm (2.0\%+8)$	
60.00M $\Omega$	0.01M $\Omega$		

- Measurement result = displayed value – resistance of shorted test leads
- Open circuit voltage: About 1V
- Accuracy guarantee: 5%~100% of range

## 8) Continuity ( $\bullet \rightarrow \bullet$ )

Range	Resolution	Accuracy	Overload Protection
600.0 $\Omega$	0.1 $\Omega$	Open circuit: Resistance $\geq 70\Omega$ , no beep Well-connected circuit: Resistance $\leq 30\Omega$ , consecutive beeps	1000V DC/AC

- Open circuit voltage: About 1V
- Resistance value is between 30 $\Omega$  and 70 $\Omega$ , the Buzzer may beep

## 9) Diode ( $\rightarrow \vdash$ )

Range	Resolution	Accuracy	Overload Protection
6.000V	0.001V	Open circuit voltage: About 3V Measurable PN junction: Forward voltage drop $\leq 3V$ For silicon PN junction, the normal value is generally about 0.5~0.8V.	1000V DC/AC

## 10) Capacitance ( $\overline{C}$ )

Range	Resolution	Accuracy	Overload Protection
60.00nF	0.01nF	$\pm (4.0\%+25)$	1000V DC/AC
600.0nF	0.1nF	$\pm (4.0\%+5)$	
6.000 $\mu$ F	0.001 $\mu$ F		
60.00 $\mu$ F	0.01 $\mu$ F		
600.0 $\mu$ F	0.1 $\mu$ F	$\pm (10.0\%+9)$	
6.000mF	0.001mF		
60.00mF	0.01mF		

- Measurement result = displayed value – capacitance of open-circuit test leads
- For capacitance  $\leq 1\mu\text{F}$ , it is recommended to use "REL" measurement mode.
- Accuracy guarantee: 5%~100% of range

### 11L: fYei YbW#B i hmF Uhc`fk ni L

Range	Resolution	Accuracy	Overload Protection
10Hz~1 MHz	0.01Hz~1K Hz	$\pm (0.1\%+3)$	1000V DC/AC
10.0%~90.0%	0.1%	$\pm (2.6\%+7)$	

- Frequency input amplitude:
  - 10Hz~100kHz:  $250\text{mVrms} \leq \text{input amplitude} \leq 20\text{Vrms}$
  - 100kHz~1MHz:  $600\text{mVrms} \leq \text{input amplitude} \leq 20\text{Vrms}$
- Duty ratio:
  - 10%~90%: for square waves of 10Hz~1kHz
  - 30%~70%: for square waves of 1kHz~10kHz
  - $2\text{Vpp} \leq \text{input amplitude} \leq 20\text{Vpp}$

### %2LBcb!V#bH#W#5 7`j c`HJ[ Y`gYbg]b[ `fB7 JL

Range	Accuracy	Overload Protection
NCV	Bring the NCV sensor (upper tip) close to a wire to start sensing. When no voltage is sensed, the LCD displays "EF". As the intensity of the detected voltage increases, more segments "—" will be displayed, and higher frequently occurs for buzzer and flashing LED.	1000V DC/AC

## ±" CdYfU]b[ `#bgfi W]cbg

### 1. FYUH'X'A YUgi fYa YbhcZ57`7i ffYbhfD]Wi fY'3L

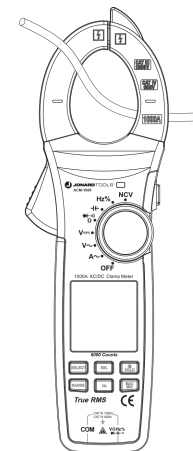

Picture 3

### AC Current Measurement

- 1) Turn the function dial to **A~** position.
- 2) Press the trigger to open clamp jaws and fully enclose one conductor (only one conductor can be measured at a time). For optimum results, center the conductor in the jaws.

### Current Frequency Measurement

- 1) When the function dial is in the AC current position, short press the Hz button to enter the frequency measurement mode.
- 2) Short press the Hz button again to exit the frequency measurement mode.



## 2. Related Measurement of AC Voltage (Picture 4)

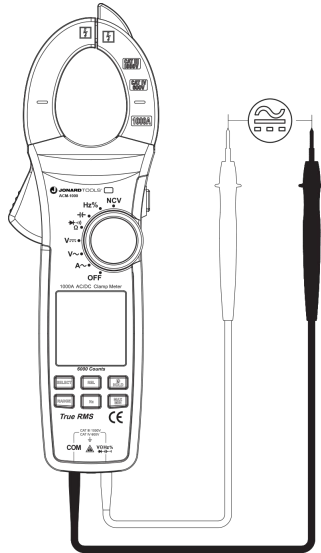

Picture 4

### AC Voltage Measurement

- 1) Insert the red test lead into  $V\Omega Hz\%$  jack, and black test lead into the COM jack.
- 2) Turn the function dial to  $V\sim$  or  $V\approx$  position.
- 3) Short press the SELECT button to switch to AC voltage measurement if required, and connect the test leads with the measured load or power supply in parallel.

### Voltage Frequency Measurement

- 1) When the function dial is in the AC voltage, short press Hz button to enter the frequency measurement mode.
- 2) Short press Hz button again to exit frequency measurement mode.

## 3. DC Voltage Measurement (Picture 4)

- 1) Insert the red test lead into the  $V\Omega Hz\%$  jack, and black test lead into the COM jack.
- 2) Turn the function dial to the  $V=$  or  $V\approx$  position.
- 3) Short press the SELECT button to switch to DC voltage measurement if required, and connect the test leads with the measured load or power supply in parallel.
- 4) Read the voltage value on the display.

### ⚠ Note:

- Do not input voltage above 1000V. Although it is possible to measure higher voltage, it may damage the meter.
- Be cautious to avoid electrical shock when measuring high voltage.
- After completing the measurement, disconnect the test leads from the circuit under test.
- Test known voltage before use to verify whether the product functions properly.
- When the measured voltage is above 30V, the LCD will display the high voltage alarm prompt "⚡".
- When measuring at 600mV range, use "REL" measurement mode to get accurate readings. Short-circuit the test leads, and then short press the REL or REL ZERO button. Read the measured voltage after the voltage of the short-circuited test leads is automatically subtracted.

## 4. Resistance Measurement (Picture 5)

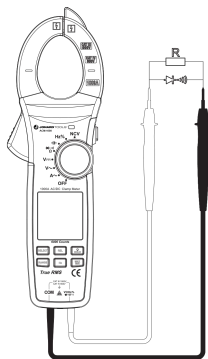

Picture 5

- 1) Insert the red test lead into the  $\frac{V\Omega Hz}{\rightarrow (+)}$  jack, and black test lead into the COM jack.
- 2) Turn the function dial to the  $\frac{\Omega}{\rightarrow}$  position, short press the SELECT button to switch to resistance measurement if required, and connect the test leads with both ends of the measured resistance in parallel.

### **Note:**

- If the measured resistor is open or the resistance exceeds the maximum range, the LCD will display “OL”.
- Before measuring the resistance online, switch off the power supply of the circuit, and fully discharge all capacitors to ensure accurate measurement.
- When measuring low resistance, the test leads will produce 0.1 $\Omega$ ~0.2 $\Omega$  measurement error. Use “REL” measurement mode to get accurate readings. Short-circuit the test leads, and then short press the REL or REL ZERO button. After the meter automatically subtracts the resistance of the short-circuited test leads, the low-resistance measurement can be performed.
- If the resistance is not less than 0.5 $\Omega$  when the test leads are short-circuited, please check the test leads for abnormalities.

- When measuring resistance above 1M $\Omega$ , it is normal to take a few seconds to stabilize reading.
- Use caution when working with voltage above AC 30Vrms, 42Vpeak or DC 60V. Those voltages may pose shock hazard.
- After completing the measurement, disconnect the test leads from the circuit under test.

## 5. Continuity Test (Picture 5)

- 1) Insert the red test lead into the  $\frac{V\Omega Hz}{\rightarrow (+)}$  jack, and black test lead into the COM jack.
- 2) Turn the function dial to  $\frac{\Omega}{\rightarrow}$  position, short press SELECT button to switch to continuity test, and connect the test leads with both ends of measured load in parallel.
- 3) When the measured resistance  $\leq 30\Omega$ : The circuit is in good conduction status; the buzzer beeps continuously. When measured resistance  $\geq 70\Omega$ : there will be no buzzer sound.

### **Note:**

- Before measuring the continuity online, switch off the power supply of the circuit, and fully discharge all capacitors.
- Use caution when working with voltage above AC 30Vrms, 42Vpeak or DC 60V. Those voltages may pose shock hazard.
- After completing the measurement, disconnect the test leads from the circuit under test.

## 6. Diode Test (Picture 5)

- 1) Insert the red test lead into the  $\frac{V\Omega Hz}{\rightarrow (+)}$  jack, and black test lead into the COM jack. The polarity of the red test lead is “+” and that of the black test lead is “-”.
- 2) Turn the function dial to the  $\frac{\Omega}{\rightarrow}$  position, and short press the SELECT button to switch to diode test.

- 3) Connect the red probe with the diode anode, and black with the diode cathode.
- 4) Read the approximate forward voltage of the diode on the display. For silicon PN junction, the normal value is generally about 500~800 mV.

**⚠ Note:**

- If the diode is open or its polarity is reversed, the LCD will display “OL”.
- Before measuring the diode online, switch off the power supply of the circuit, and fully discharge all capacitors.
- Use caution when working with voltage above AC 30Vrms, 42Vpeak or DC 60V. Such voltage poses a shock hazard.
- After completing the measurement, disconnect the test leads from the circuit under test.

## 7. Capacitance Measurement (Picture 6)

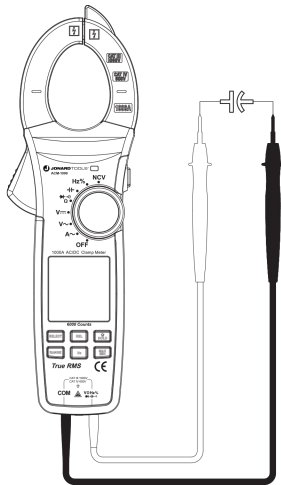

Picture 6

- 1) Insert the red test lead into the  $\frac{V\Omega Hz}{\leftarrow \rightarrow}$  jack, and black into the COM jack.
- 2) Turn the function dial to the  $\leftarrow \rightarrow$  position, short press the SELECT button to switch to capacitance measurement, and connect the test leads with both ends of the measured capacitance in parallel.

**⚠ Note:**

- If the measured capacitor is short-circuited or the capacitance exceeds the maximum range, the LCD will display “OL”.
- The analog bar pointer is disabled in capacitance measurement mode. When measuring capacitance  $>600\mu F$ , it may take some time to steady the readings.
- Before measuring, fully discharge all capacitors (especially high-voltage capacitors) to avoid damage to the meter and user.
- After completing the measurement, disconnect the test leads from the circuit under test.

## 8. Frequency/Duty Rate Measurement (Picture 7)

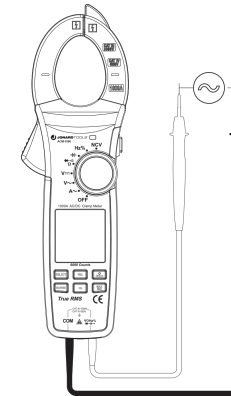

Picture 7

- 1) Insert the red test lead into the  $\frac{V_{0.1Hz\%}}{99-100}$  jack, and black into the COM jack.
- 2) Turn the function dial to the Hz% position, and connect the test leads with both ends of the measured signal source in parallel.
- 3) Short press the SELECT button to switch to frequency/duty ratio measurement.

**⚠ Note:**

- Do not input voltage higher than 30Vrms to avoid personal injury.
- After completing the measurement, disconnect the test leads from the circuit under test.

## 9. Non-contact AC Voltage Sensing (NCV) (Picture 8)

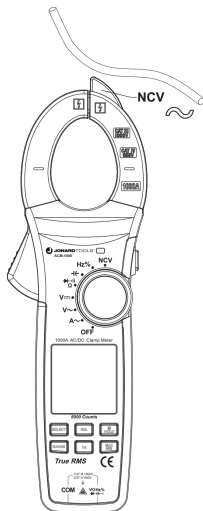

Picture 8

- 1) Turn the function dial to the NCV position, and bring the NCV sensor close to the wire under test.
- 2) If there is AC voltage or electromagnetic field in the space, the LCD will display the sensing intensity from weak to strong by “—”. At the same time, the buzzer will beep intermittently and the LED indicator light will be on. When no voltage is sensed, the LCD displays “EF”.

## 10. Auto Power Off

During measurement, if there is no operation of the function dial or any button for 15 minutes, the meter will automatically shut down to save power. Users can wake it up by pressing any button (except FLIGHT button). To disable the auto-off function, press and hold the SELECT button in the off state and turn on the meter.

## 11. Use of Test Leads

### 1) Testing in CAT III/CAT IV measurement locations:

Ensure the test lead shields are pressed firmly in place. Failure to use the CATIII/CATIV shields increases arc-flash risk.

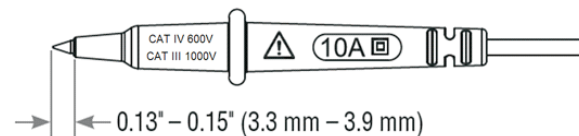

### 2) Testing in CAT II measurement locations:

CAT III/CAT IV shields may be removed for CAT II locations. This will allow testing on recessed conductors such as standard wall outlets. Take care not to lose the shields.

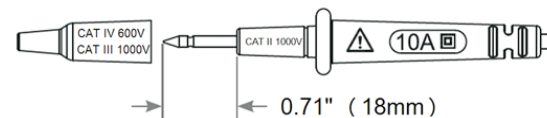

## X. Maintenance

 Warning: Before opening the rear cover of the meter, remove the test leads to avoid electric shock.

### 1.General Maintenance

- 1) The maintenance and service must be implemented by qualified professionals or designated departments.
- 2) Clean the meter casing with a soft cloth and mild detergent. Do not use abrasives or solvents!

### 2.Battery Replacement (Picture 9)

- 1) Turn off the meter and remove the test leads from the input jacks.
- 2) Unscrew and remove the battery cover.
- 3) Replace with 3 standard AAA batteries according to the polarity indication.
- 4) Secure the battery cover and tighten the screw.

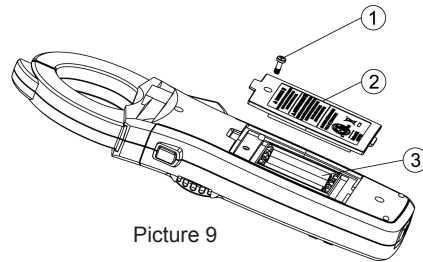

Picture 9

### 3.Test Lead Replacement

If the insulation on the test lead is damaged, replace it.

#### Warning:

Test leads used for MAINS measurement should meet EN 61010-031 standard, rated CAT III 1000V CAT IV 600V , 10A or better.

